

M2I Corporation

Industrial HMI TOPRB Series

Hardware Manual

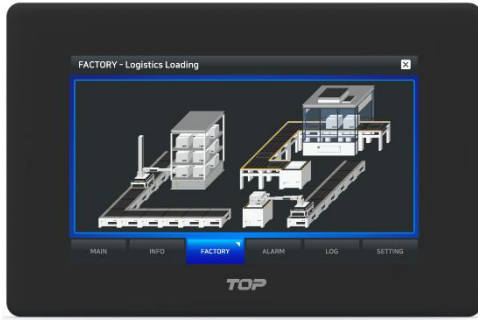

Thank you for purchasing the industrial HMI touch panel series from M2I Corporation.

To ensure safe and proper use of the product, please make sure to thoroughly read this manual, which includes installation, wiring, and operational instructions, before use.





Contents

Contents.....	2
Chapter 1 Safety Precautions.....	3
Chapter 1 Précautions de sécurité	5
Chapter 2 Overview	7
2.1 Introduction of Products.....	7
2.2 Components.....	7
2.3 Model Name Description	7
Chapter 3 General Specifications	8
3.1 Power Specifications	8
3.2 Memory Specifications.....	8
3.3 Display Specifications	8
3.4 Touch Specifications	8
3.5 Environment Specifications.....	8
3.6 Structure Specifications	8
Chapter 4 Parts Identification and Functions.....	9
4.1 TOPRB0400WD	9
4.2 TOPRB0700WD	11
4.3 TOPRB1000WD	13
Chapter 5 Interface	15
5.1 Serial Interface	15
5.2 Ethernet Interface.....	17
5.3 USB Interface	18
Chapter 6 Installation	18
6.1 Installation Requirements.....	18
6.2 Installation Procedure.....	19
Chapter 7 Wiring	20
7.1 Power Wiring.....	20
7.2 Grounding wiring.....	21
Chapter 8 Maintenance	21
8.1 Cleaning the Display.....	21
8.2 Periodic Check Points.....	21
8.3 Device Troubleshooting	22
8.4 Setting System Recovery Mode.....	22
Chapter 9 Products Labels	23







Chapter 1 Safety Precautions

■ Before using the product





To ensure the safe and efficient use of the product, please read this manual thoroughly and completely before use. The safety precautions must be followed to prevent accidents and hazards. These precautions are divided into "Warning" and "Caution" sections. The meanings of each category are as follows.

 Warning	Violating the instruction may result in serious personal injury or death.
 Caution	Violating the instruction may result in slight personal injury or product damage.
	Be cautious, for danger may be present.
	Be cautious, for there is a possibility of an electric shock.



■ General Precautions **Caution**

-  Do not press the screen with hard or pointed objects (such as an awl, screwdriver, or pen), or apply excessive force. This may cause damage to the front sheet or malfunction of the touch screen.
-  Do not use or store the product in highly vibrating environment.
-  Ensure that foreign substances such as water, liquids, or metal particles do not enter the product. This may lead to damage or electric shock.
-  Keep radios or mobile phones at least 30 cm (12 inches) away from the device.
-  The LCD screen may display up to two bright dots or have areas that appear slightly brighter. These are characteristics of LCDs and do not indicate a defect.
-  Do not store or operate the device under direct sunlight, as it may alter the characteristics of the LCD.
WARNING – DO NOT CONNECT OR DISCONNECT WHEN ENERGIZED. or equivalent.
AVERTISSEMENT – NE PAS CONNECTER OU DÉCONNECTER LORSQUE L'ÉQUIPEMENT EST SOUS TENSION.

■ Design Precautions **Warning**

-  In the event of an abnormality in the external power supply or this product, install an external protection circuit to safeguard the overall control system.
-  Malfunctions or incorrect outputs from the main unit may cause serious harm to system stability or human safety. Therefore, be sure to install external safety devices such as an emergency stop switch, upper/lower limit switches, and forward/reverse operation interlock circuits to prevent physical damage to the system.
-  When a computer or other external device exchanges data with the main unit or controls its status (e.g., switching operation modes) via communication, ensure that the sequence program includes interlock functions to protect the system from communication errors.
-  Input/output signals and communication lines must be routed at least 100 mm (3.94 inches) away from high-voltage or power lines. In particular, communication-related I/O lines must be installed separately from power lines.

■ Wiring Precautions **Warning**

-  Before starting any wiring work, check the rated voltage and terminal layout of each product, and ensure all wiring is performed correctly. Incorrect wiring may result in fire, electric shock, or malfunction.
-  When wiring, be sure to tighten terminal screws to the specified torque (4.4 lb.in). Loose screws may cause short circuits, fire, or malfunction.
-  The FG (Frame Ground) terminal must be grounded using a dedicated grounding line. Improper grounding

may cause system malfunction.

- ❗ a. Use a Class 3 grounding method with a grounding wire of at least 2 mm².
- ❗ b. The grounding point should be as close to the main unit as possible, and the grounding wire should be kept as short as possible.

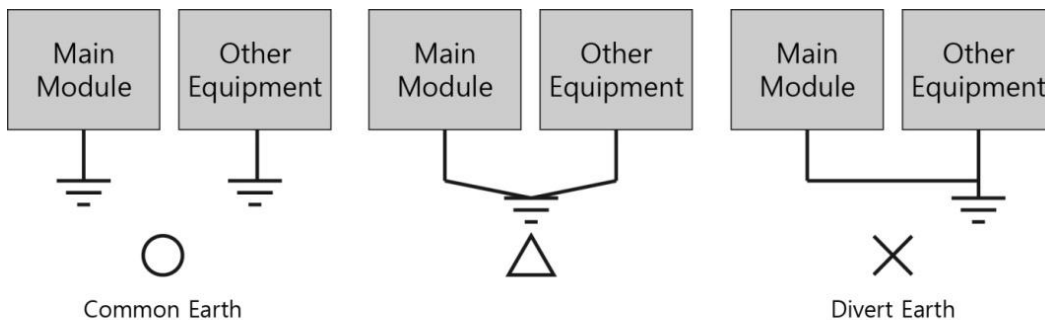

Fig. Grounding Example Diagram

■ Installation Precautions ⚠ Caution

- ⊘ Do not install the product in locations where the temperature exceeds the allowable range, as this may cause damage to the unit or reduce its lifespan.
- ⊘ Do not install the product in the following environments:
 - Locations where the ambient temperature is outside the range of -10 °C to 50 °C
 - Surfaces of control panels where high-voltage equipment is installed
- ⊘ Do not install the unit in areas subject to continuous strong shock or vibration.
- ⊘ Use only at altitudes below 2,000 meters.
- ⊘ This product does not guarantee front-side protection by default. Attach a protective film or cover suitable for the operating environment to the display surface. Failure to do so may result in damage or malfunction due to impact, contamination, or the ingress of foreign substances.
- ⊘ For indoor use only.
- ⊘ The equipment shall only be used in an area of pollution degree 2, as defined in KS C IEC 60664-1

■ Disposal Precaution ⚠ Caution

When disposing of the product and battery, treat them as industrial waste. Improper disposal may result in the release of toxic substances or cause explosions.

■ Internal Battery Specifications and Replacement

- ⊘ The CR2032 internal battery on the mainboard may only be replaced in non-explosive environments. Please refer to the following information to ensure proper replacement procedures.

Items	Specifications
Voltage and Capacity	DC 3 V, 240 mAh
Model Name and Manufacturer	CR2032 (Lithium Battery), Changzhou Yufeng Battery
Battery Life	More than 2 years (In case of ambient temperature 25 °C)

* Specifications may vary depending on the model.





■ Wiring Connection Specifications

Wiring connected to the product must be from an isolated secondary source or Class 2 circuit with a limited voltage / current and output fuse, operating at 24 VDC or below.







Chapter 1 Précautions de sécurité

■ Avant d'utiliser le produit

Veillez lire et utiliser ce manuel entièrement pour utiliser le produit en toute sécurité et de manière efficace. Les précautions de sécurité doivent être respectées afin de prévenir les accidents ou les dangers, et sont classées en « AVERTISSEMENT » et « ATTENTION ». La signification de chaque élément est indiquée ci-dessous.





 Warning	AVERTISSEMENT: Si les instructions ne sont pas suivies, cela peut entraîner une situation dangereuse avec des blessures graves ou la mort.
 Caution	ATTENTION : Si les instructions ne sont pas respectées, situation dangereuse pouvant entraîner des blessures graves, des blessures légères ou des dommages au produit.
	Des situations dangereuses pouvant survenir, veuillez prêter une attention particulière.
	Soyez prudent car un choc électrique peut se produire.

■ Précautions générales **Caution**

-  Ne pas appuyer sur l'écran avec des objets durs ou pointus (aiguille, tournevis, stylo, etc.) ni appliquer de force excessive. Cela peut endommager la feuille avant et causer des dysfonctionnements du toucher.
-  Ne pas utiliser ou stocker dans des environnements soumis à des vibrations importantes.
-  Veillez à ce que l'eau, les liquides, la poussière de métal et autres corps étrangers n'entrent pas à l'intérieur du produit. Cela peut provoquer des dommages ou une électrocution.
-  Ne pas utiliser les radios ou téléphones portables à moins de 30 cm du boîtier principal.
-  Des points lumineux au nombre de 2 au maximum peuvent apparaître sur l'écran LCD, ou certaines parties peuvent paraître plus lumineuses. Ceci est un phénomène dû aux caractéristiques de l'écran LCD et ne constitue pas un défaut.
-  Ne stockez pas et n'utilisez pas l'appareil dans des endroits exposés à la lumière directe du soleil. La lumière directe du soleil peut modifier les caractéristiques de l'affichage LCD.

AVERTISSEMENT – NE PAS CONNECTER OU DÉCONNECTER LORSQUE L'ÉQUIPEMENT EST SOUS TENSION.

■ Précautions de conception **Warning**

-  En cas de dysfonctionnement de l'alimentation externe ou de ce produit, installez un circuit de protection à l'extérieur du boîtier principal pour protéger l'ensemble du système de contrôle.
-  En cas de sortie excessive ou de dysfonctionnement de l'unité principale, cela pourrait compromettre la stabilité de l'ensemble du système et causer de graves problèmes pour la santé humaine. Par conséquent, installez impérativement des dispositifs de protection contre les dommages physiques du système tels que des interrupteurs d'arrêt d'urgence, des interrupteurs de limitation supérieure/inférieure, et des circuits d'interlock de fonctionnement avant/arrière à l'extérieur de l'unité principale.
-  Lorsqu'un ordinateur ou tout autre dispositif externe échange des données avec l'unité principale ou manipule l'état de celle-ci via la communication (changement de mode de fonctionnement), veuillez configurer un interlock dans le programme de séquence afin de protéger le système contre les erreurs de communication.
-  Câblez les signaux d'entrée/sortie ou les câbles de communication à une distance minimale de 100 mm (3.94 inch) par rapport aux câbles haute tension ou aux câbles de puissance. En particulier, les signaux d'entrée/sortie liés à la communication doivent être installés séparément des câbles d'alimentation.

■ Précautions de câblage **Warning**

-  Avant de commencer le raccordement, vérifiez la tension nominale et la disposition des bornes de chaque

produit, puis effectuez le raccordement correctement.

Un câblage incorrect peut provoquer un incendie, une électrocution ou un mauvais fonctionnement.

- ❗ Lors du câblage, serrez fermement la vis du terminal au couple réglementaire (4.4 lb.in). Un serrage insuffisant de la vis peut provoquer un court-circuit, un incendie ou un dysfonctionnement.
- ❗ La mise à la terre de la borne FG doit être effectuée à l'aide d'une mise à la terre dédiée. L'absence de mise à la terre peut être à l'origine de dysfonctionnements.
- ❗ a. La mise à la terre doit être de type 3 ; le fil de mise à la terre doit être de 2 mm².
- ❗ b. Positionnez le point de terre aussi proche que possible du boîtier et minimisez la longueur du fil de terre.

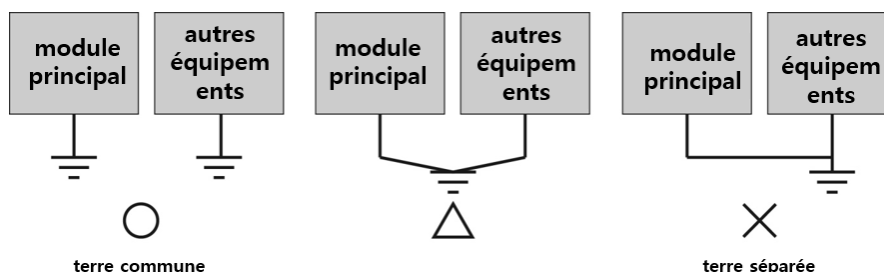

fig. : exemple de schéma de mise à la terre

■ Précautions d'installation ⚠ Caution

- ⊘ Ne pas installer dans un endroit où la température dépasse les valeurs autorisées. L'appareil peut être endommagé ou sa durée de vie peut être réduite.
- ⊘ Ne pas installer dans des endroits dont l'environnement d'installation est le suivant.
 - Lieu en dehors de la plage de température ambiante de -10 à 50 °C
 - La surface du tableau de commande équipé d'un équipement à haute tension
- ⊘ Ne pas installer dans un lieu où l'unité principale est soumise à de fortes chocs et vibrations continus.
- ⊘ Utiliser uniquement à une altitude de 2,000 m ou moins.
- ⊘ Ce produit ne garantit pas la protection frontale par défaut. Fixez une feuille de protection adaptée à l'environnement d'utilisation sur la surface de l'afficheur. En l'absence de feuille de protection, des dommages ou un fonctionnement anormal du produit peuvent survenir en raison d'un choc, d'une contamination ou de l'intrusion de corps étrangers.
- ⊘ Utilisation en intérieur uniquement.
- ⊘ L'équipement doit être utilisé uniquement dans des endroits présentant une catégorie de contamination d'au moins 2, telle que définie dans KS C IEC 60664-1.

■ Précautions de mise au rebut ⚠ Caution

Lors de la mise au rebut du produit et de la batterie interne, traitez-les comme des déchets industriels. Il existe un risque de dégagement de substances toxiques ou d'explosion.

■ Spécifications de la batterie interne et remplacement

- ⊘ La batterie interne CR2032 montée sur la carte mère est remplaçable. Pour effectuer le remplacement correctement, veuillez consulter les informations ci-dessous.

Élément	Spécifications
Tension et capacité de la batterie interne	DC 3 V, 240 mAh
Désignation et fabricant de la batterie interne	CR2032 (pile lithium), Changzhou Yufeng Battery
Durée de vie de la batterie	Environ 2 ans ou plus (pour une température ambiante de 25 °C)

* Les spécifications peuvent varier selon le modèle.

■ Spécifications de câblage

Le câblage de connexion au produit doit être réalisé à partir d'une source secondaire isolée de 24 Vdc maximum, avec limitation de tension/courant et fusible de sortie, ou dans un circuit secondaire conforme à la norme Class 2.

Chapter 2 Overview





2.1 Introduction of Products

This industrial HMI touch panel is an industrial control device required in industrial field. It is a device based on RS-232C and RS-422 / 485, Ethernet which is used for the basic purpose of communication with another device (PLC).

2.2 Components

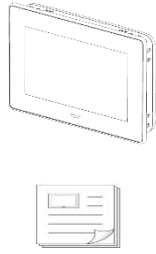
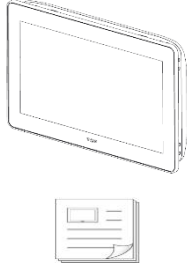
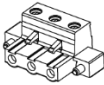
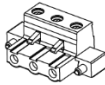
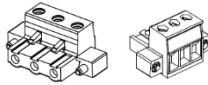
The components of the product are as follows.

Before using the product, please check that all of the following components are included.

Components	Illustration			Quantity
	TOPRB0400WD	TOPRB0700WD	TOPRB1000WD	
Product and Manual				1 each
Power Connector and COM3 Connector				1 each
Body Clamp				6
Accessories (Sold separate)	 Extension Cable  USB Memory			User Options

2.3 Model Name Description

Series	Screen Size	Option	Resolution	Power
TOPRB	04: 4.3" 07: 7.0" 10: 10.1"	00: Standard	W: WQVGA (480 * 272) W: WVGA (800 * 480) W: WSVGA (1024 * 600)	D: DC

Chapter 3 General Specifications

3.1 Power Specifications

Input Voltage	DC 24 V, Class 2	
Input Voltage Range	DC 20 ~ 28 V, Class 2	
Power Consumption	TOPRB0400WD	15 W
	TOPRB0700WD	
	TOPRB1000WD	
Voltage endurance	DC 24 V, 10 ms within	
Insulation Resistance	500 V DC, 10 MΩ	

3.2 Memory Specifications

Screen Memory	128 MB
Backup Memory	512 KB: System buffer (10 K Word), Including Alarm / Log / Recipe
Backup Period	Permanent
Real Time Clock	Built in (by Battery)

3.3 Display Specifications

Color	16 M colors
Brightness Level	10 Level (by software)
Backlight Type	LED
Backlight Life	50,000 hours
Display Font	MS Windows Vector font possible Image font
Front LED Indicate	Built in

3.4 Touch Specifications

Touch Type	Built in, Analog resistive type
------------	---------------------------------

3.5 Environment Specifications

Operation Temperature (°C)	-10 ~ +50
Storage Temperature (°C)	-20 ~ +60
Operation Humidity (%RH)	0 ~ 90 (No dew)
Atmosphere	No corrosive gas
Vibration Endurance	Amplitude: $10 \leq F < 25$ Hz (2G) X, Y, Z each direction (for 30 minutes)
Noise Immunity	1000 Vp-p (Pulse width 1 μs)
Electrostatic Discharge	Connective discharge from EN61000-4-2: ±4 kV
Shock Endurance	10G X, Y, Z each direction (for 3 times)
Withstand Voltage	500 V (Line-Line)
Ground Connection	Class 3 (Under 100 Ω)
Insulation Coordination	Overvoltage Category II

3.6 Structure Specifications

Model	TOPRB0400WD	TOPRB0700WD	TOPRB1000WD
Weight (Kg)	0.22	0.48	0.8
Cooling System	Natural air circulation		
Case Material	Plastic		

Chapter 4 Parts Identification and Functions

4.1 TOPRB0400WD

4.1.1 Overall Appearance and Dimensions

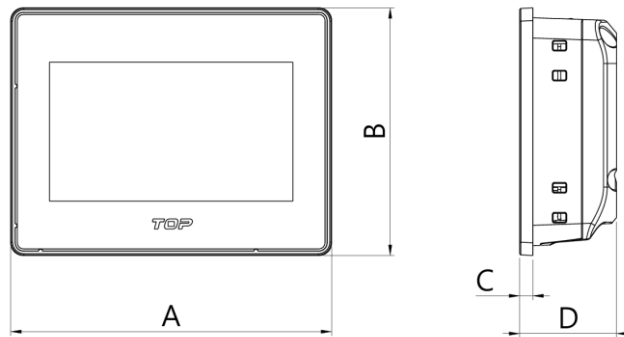
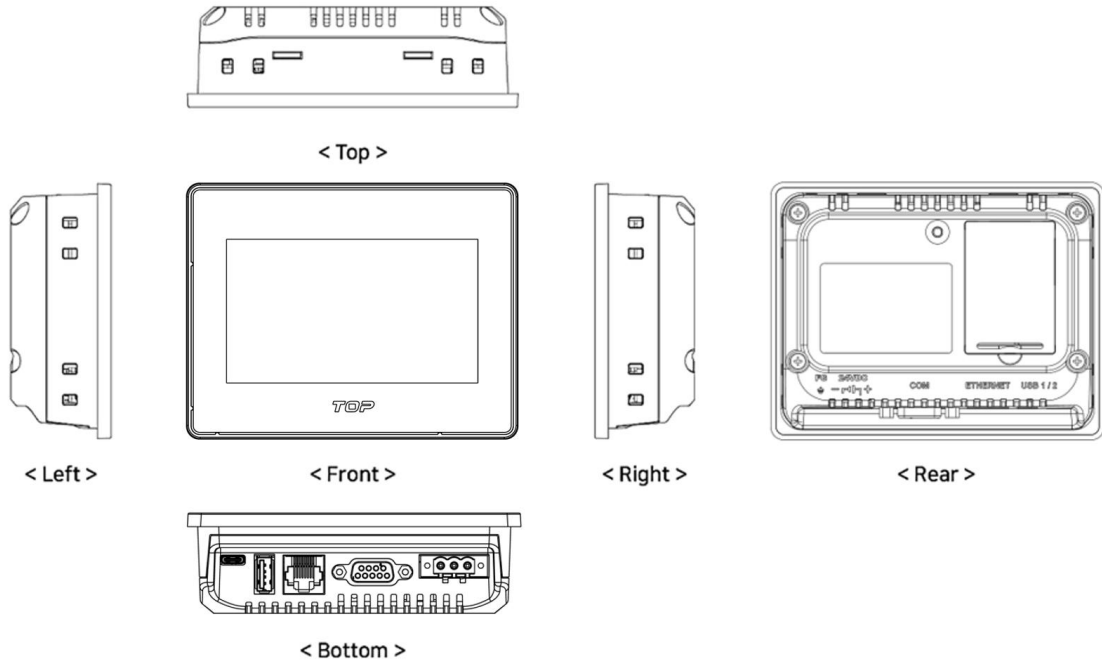

(mm)

Model	A	B	C	D
TOPRB0400WD	126.6	97.6	5.2	38.2

4.1.2 Front Section Components and Specifications



No.	Components	Description
①	LCD	TFT LCD, 16M colors
②	Touch Panel	Analog Touch Panel

4.1.3 Rear Section Components and Specifications

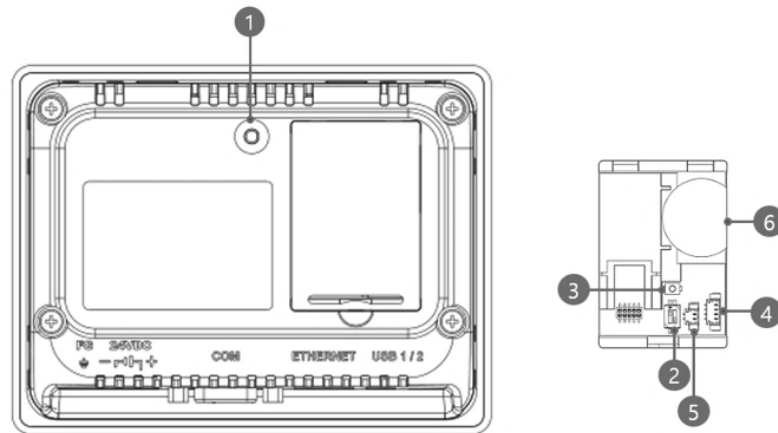

No.	Components	Type	Description
①	LED Indicator	1ea	Operation status display
②	Mode Switch	DIP Switch 2P	System mode selection switch
③	Reset Switch	Tact Switch	System reset switch
④	Diagnosis Connector	1.25 mm 4P	System diagnosis (for manufacturer use only)
⑤	Battery Connector	1.25 mm 2P	RTC battery connector
⑥	RTC Battery	CR2032	RTC battery

4.1.4 Bottom Section Components and Specifications

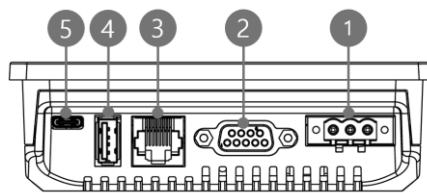

No.	Components	Type	Description
①	Power Input Terminal	TB 5 mm 3P	Power supply for product
②	Serial COM1 / COM2 Connector	D-sub 9P	COM1: RS-232C Serial Comm., COM2: RS-422 / 485 Serial Comm. (select by software),
③	Ethernet Connector	RJ-45	10BASE-T / 100BASE-TX, Auto-MDIX
④	USB Host	Type-A	USB port for external storage (optional)
⑤	USB Device	Type-C	USB port for uploading or downloading project files

4.2 TOPRB0700WD

4.2.1 Overall Appearance and Dimensions

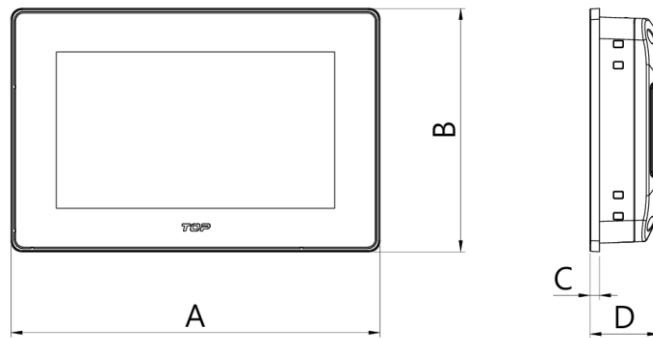
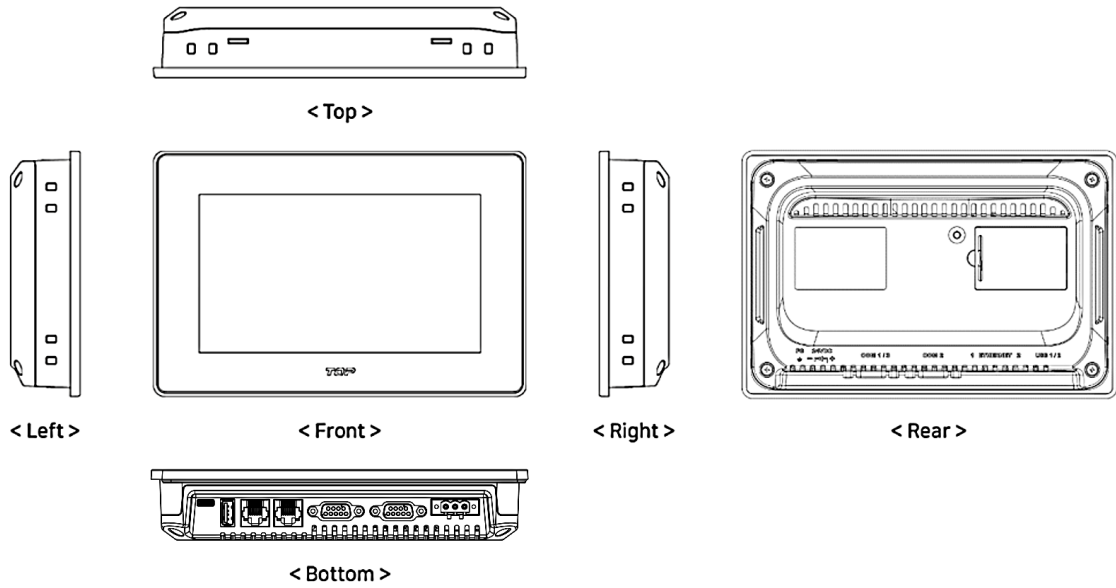

Model	A	B	C	D
TOPRB0700WD	205.4	135.4	5.3	38.3

(mm)

4.2.2 Front Section Components and Specifications

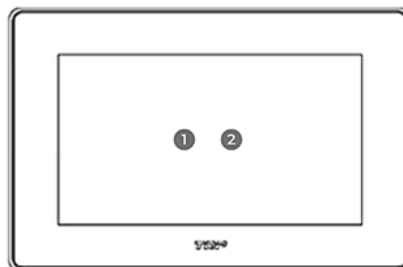

No.	Components	Description
①	LCD	TFT LCD, 16M colors
②	Touch Panel	Analog Touch Panel

4.2.3 Rear Section Components and Specifications

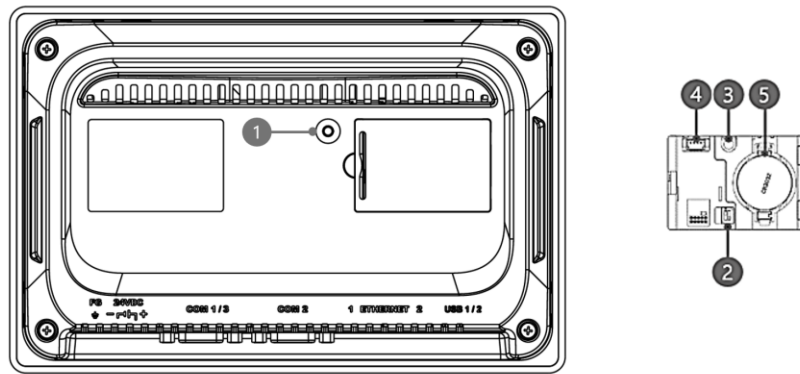

No.	Components	Type	Description
①	LED Indicator	1ea	Operation status display
②	Mode Switch	DIP Switch 2P	System mode selection switch
③	Reset Switch	Tact Switch	System reset switch
④	Diagnosis Connector	1.25 mm 4P	System diagnosis (for manufacturer use only)
⑤	RTC Battery	CR2032	RTC battery

4.2.4 Bottom Section Components and Specifications

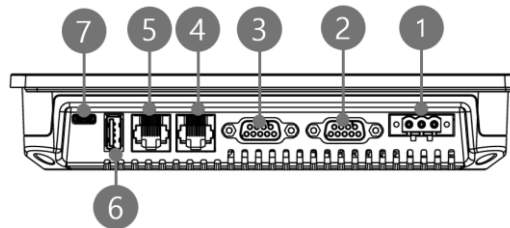

No.	Components	Type	Description
①	Power Input Terminal	TB 5 mm 3P	Power supply for the product
②	Serial COM1 / COM3 Connector	D-sub 9P	COM1: RS-232C Serial Comm COM3: RS-485 Serial Comm.
③	Serial COM2 Connector	D-sub 9P	RS-232C / 422 / 485 Serial Comm. (Selectable via software)
④	Ethernet 1 Connector	RJ-45	10BASE-T / 100BASE-TX, Auto-MDIX
⑤	Ethernet 2 Connector	RJ-45	10BASE-T / 100BASE-TX, Auto-MDIX
⑥	USB Host	Type-A	USB Port for External Storage Device Connection
⑦	USB Device	Type-C	USB port for uploading or downloading project files

4.3 TOPRB1000WD

4.3.1 Overall Appearance and Dimensions

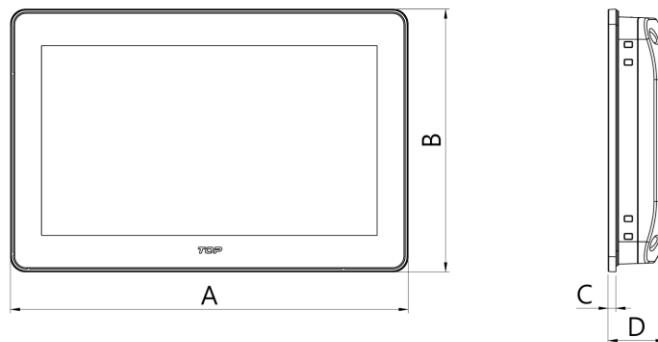
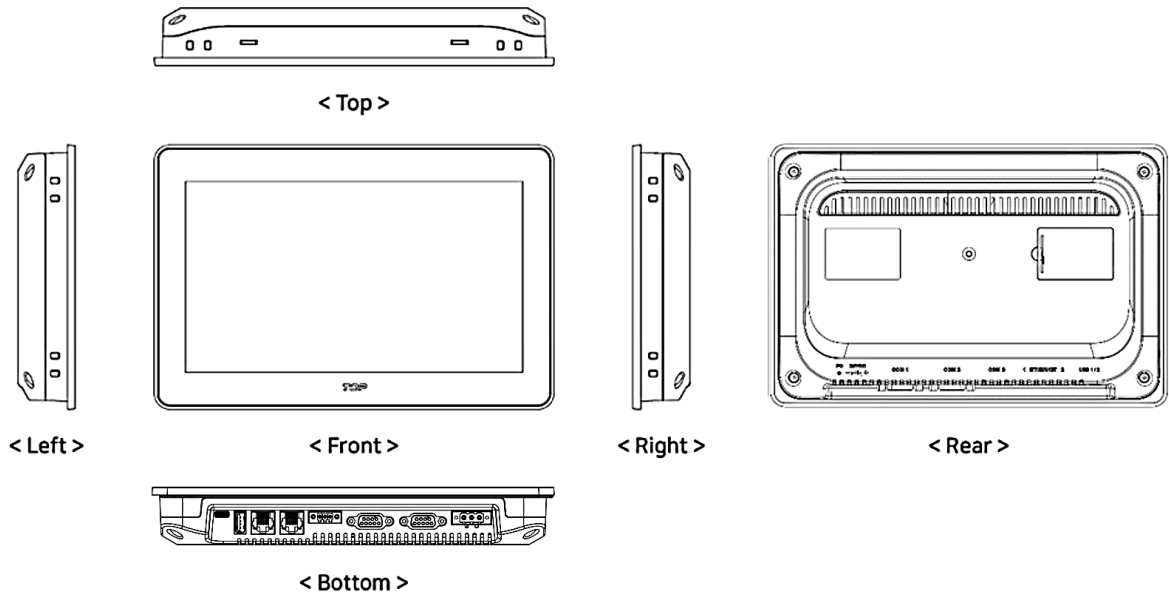

(mm)

Model	F1	F2	C	D
TOPRB1000WD	265	175	5.2	38

4.3.2 Front Section Components and Specifications

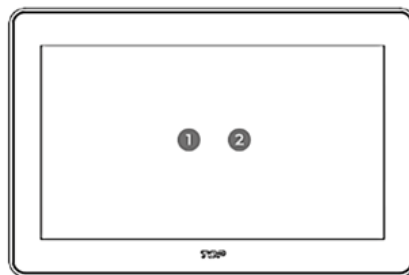

No.	Components	Description
①	LCD	TFT LCD, 16M colors
②	Touch Panel	Analog Touch Panel

4.3.3 Rear Section Components and Specifications

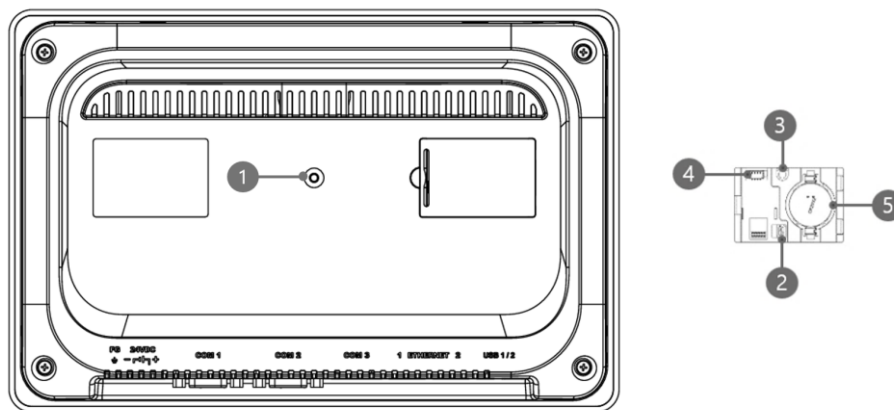

No.	Components	Type	Description
①	LED Indicator	1ea	Operation status display
②	Mode Switch	DIP Switch 2P	System mode selection switch
③	Reset Switch	Tact Switch	System reset switch
④	Diagnosis Connector	1.25 mm 4P	System diagnosis (for manufacturer use only)
⑤	RTC Battery	CR2032	RTC battery

4.3.4 Bottom Section Components and Specifications

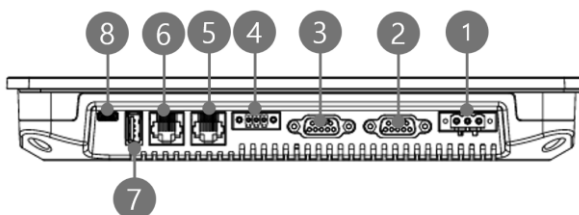

No.	Components	Type	Description
①	Power Input Terminal	TB 5 mm 3P	Power supply for the product
②	Serial COM1 Connector	D-sub 9P	RS-232C Serial Comm.
③	Serial COM2 Connector	D-sub 9P	RS-232C / 422 / 485 Serial Comm. (Selectable via software)
④	Serial COM3 Connector	3.5 mm 3P	RS-485 Serial Comm.
⑤	Ethernet 1 Connector	RJ-45	10BASE-T / 100BASE-TX, Auto-MDIX
⑥	Ethernet 2 Connector	RJ-45	10BASE-T / 100BASE-TX, Auto-MDIX
⑦	USB Host	Type-A	USB Port for External Storage Device Connection
⑧	USB Device	Type-C	USB port for uploading or downloading project files

Chapter 5 Interface

To enable communication between this product and external devices, please refer to the following to connect the two devices.

5.1 Serial Interface

5.1.1 RS-232C

Items		Specification
Protocol		Full duplex
Synchronous Method		Asynchronous
Communication Distance		Approximately 15 m
Connection Type		1:1
Control Codes		ASCII code or HEXA code
Transmission Speed		2400, 4800, 9600, 19200, 38400, 57600, 76800, 115200, 187500 bps
Data Type	Data Bit	7, 8 bit
	Parity Bit	NONE, ODD, EVEN parity
	Stop Bit	1, 2 bit
Connector		D-sub 9pin

5.1.2 RS-422 / 485

Items		Specification
Protocol		Full duplex / Half duplex
Synchronous Method		Asynchronous
Communication Distance		Approximately 500 m
Connection Type		1:N (N ≤ 31)
Control Codes		ASCII code or HEXA code
Transmission Speed		2400, 4800, 9600, 19200, 38400, 57600, 76800, 115200, 187500 bps
Data Type	Data Bit	7, 8 bit
	Parity Bit	NONE, ODD, EVEN parity
	Stop Bit	1, 2 bit
Connector	TOPRB0400WD	D-sub 9pin
	TOPRB0700WD	D-sub 9pin
	TOPRB1000WD	D-sub 9pin / 3.5 mm 3P

5.1.3 Pin Number and Signal Names for COM1 / COM2 Connector of TOPRB0400WD

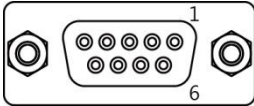
Type	Pin No.	Signal	Direction	Description
D-sub 9-pin Female 	1	RDA (RD+)	Input	RS-422 / 485 receive data(+)
	2	RD (RxD)	Input	RS-232C receive data
	3	SD (TxD)	Output	RS-232C send data
	4	RDB (RD-)	Input	RS-422 / 485 receive data(-)
	5	SG	-	Signal ground
	6	SDA (SD+)	Output	RS-422 / 485 receive data(+)
	7	NC	-	N/A
	8	NC	-	N/A
	9	SDB (SD-)	Output	RS-422 / 485 receive data(-)

5.1.4 Pin Number and Signal Names for COM1 / COM3 Connector of TOPRB0700WD

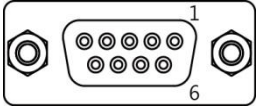
Type	Pin No.	Signal	Direction	Description
D-sub 9-pin female 	1	NC	-	N/A
	2	RD (RxD)	Input	RS-232C receive data (COM1)
	3	SD (TxD)	Output	RS-232C send data (COM1)
	4	NC	-	N/A
	5	SG	-	Signal ground (5, 9 same signal)
	6	NC	-	N/A
	7	D+	Input / Output	RS-485 data(+) (COM3)
	8	D-	Input / Output	RS-485 data(-) (COM3)
	9	SG	-	Signal ground (5, 9 same signal)

5.1.5 Pin Number and Signal Names for COM2 Connector of TOPRB0700WD

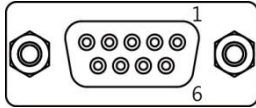
Type	Pin No.	Signal	Direction	Description
D-sub 9-pin female 	1	RDA (RD+)	Input	RS-422 / 485 receive data(+)
	2	RD (RxD)	Input	RS-232C receive data
	3	SD (TxD)	Output	RS-232C send data
	4	RDB (RD-)	Input	RS-422 / 485 receive data(-)
	5	SG	-	Signal ground
	6	SDA (SD+)	Output	RS-422 / 485 send data(+)
	7	NC	-	N/A
	8	NC	-	N/A
	9	SDB (SD-)	Output	RS-422 / 485 send data(-)

* Be sure to connect the RD and SD to the RS-232C communication line by crossing each other with a Twisted Pair Cable.

* Please connect SG directly.

* RS-422 / 485 communication line must use RDA and RDB as Twisted Pair Cable, SDA and SDB as Twisted Pair Cable.

* Communication cable's Shield cable cannot be used as communication ground. It can cause communication error.

5.1.6 Pin Number and Signal Names for COM1 Connector of TOPRB1000WD

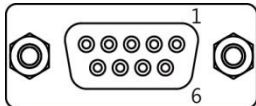
Type	Pin No.	Signal	Direction	Description
D-sub 9-pin female 	1	NC	-	N/A
	2	RD (RxD)	Input	RS-232C receive data (COM1)
	3	SD (TxD)	Output	RS-232C send data (COM1)
	4	NC	-	N/A
	5	SG	-	Signal ground
	6	NC	-	N/A
	7	NC	-	N/A
	8	NC	-	N/A
	9	NC	-	N/A

5.1.7 Pin Number and Signal Names for COM2 Connector of TOPRB1000WD

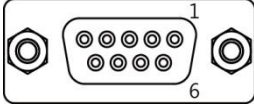
Type	Pin No.	Signal	Direction	Description
D-sub 9-pin female 	1	RDA (RD+)	Input	RS-422 / 485 receive data(+)
	2	RD (RxD)	Input	RS-232C receive data
	3	SD (TxD)	Output	RS-232C send data
	4	RDB (RD-)	Input	RS-422 / 485 receive data(-)
	5	SG	-	Signal ground
	6	SDA (SD+)	Output	RS-422 / 485 send data(+)
	7	NC	-	N/A
	8	NC	-	N/A
	9	SDB (SD-)	Output	RS-422 / 485 send data(-)

5.1.8 Pin Number and Signal Names for COM3 Connector of TOPRB1000WD

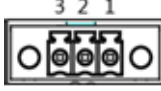
Type	Pin No.	Signal	Direction	Description
	1	D+	Input / Output	RS-485 data(+)
	2	D-	Input / Output	RS-485 data(-)
	3	SG	-	Signal ground

* Be sure to connect the RD and SD to the RS-232C communication line by crossing each other with a Twisted Pair Cable.

* Please connect SG directly.

* RS-422 / 485 communication line must use RDA and RDB as Twisted Pair Cable, SDA and SDB as Twisted Pair Cable.

* Communication cable's Shield cable cannot be used as communication ground. It can cause communication error.

5.2 Ethernet Interface

5.2.1 Ethernet

Items	Specification	
Ethernet Protocol	IEEE 802.3i / IEEE 802.3u, 10BASE-T / 100BASE-Tx	
Speed	10 Mbps / 100 Mbps	
Communication Method	Baseband	
Switching Method	Auto-MDIX	
Maximum Segment Length	100m (Between Hub)	
Communication Cable	UTP (Unshielded Twisted Pair)	
Connection Connector	TOPRB0400WD	RJ45 x 1 ch
	TOPRB0700WD	RJ45 x 2 ch
	TOPRB1000WD	RJ45 x 2 ch

5.2.2 RJ-45 Pinout

Type	Pin No.	Color	Signal
	1	Orange / White	TD+
	2	Orange	TD-
	3	Green / White	RD+
	4	Blue	Not used in 10BASE-T
	5	Blue / White	Not used in 10BASE-T
	6	Green	RD-
	7	Brown / White	Not used in 10BASE-T
	8	Brown	Not used in 10BASE-T

- * When a HUB is used, be sure to use straight cable to connect.
- Straight Cable Wiring: Connect 1:1 according to the wiring diagram above.
- * In case of do not using HUB, do not use HUB, when it is connected directly, Cross Cable should be used.
- For cross cable wiring, connect TD+ to RD+ and TD- to RD- as indicated in the wiring diagram above.

5.3 USB Interface

5.3.1 USB Host

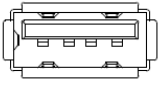
Type	Items	Specification
	USB Interface	EHCI / OHCI Specification Version 1.0, USB2.0 / 1.1 Compatible
	Transmission Method	Control / Bulk
	Transmission Speed	Max. 480 Mbps
	Support Device	USB Storage (FAT16 / FAT32 file format)
	Connector Type	USB Type-A x 1 port

5.3.2 USB Device

Type	Items	Specification
	USB Interface	USB 2.0
	Transmission Method	Interrupt / Bulk / Isochronous
	Transmission Speed	Max 480 Mbps
	Supported OS	Windows 98SE / 2000 / XP / VISTA / 7 / 10 / 11 (32/64bit)
	Cable Length	Recommended: 3 m cable (manufacturer). Use ≤ 1.5 m if purchased separately.
	Connector Type	USB Type-C (female) x 1 port
	Connection Method	Connected via USB device

Chapter 6 Installation Warning

6.1 Installation Requirements

- (1) It should be installed within $-10 \sim 50 \text{ }^{\circ}\text{C}$ and $10 \sim 90 \text{ \%RH}$, otherwise the screen may be changed or cause malfunction and damage.
- (2) Ensure that the ambient temperature does not exceed the operating temperature specified for each model.

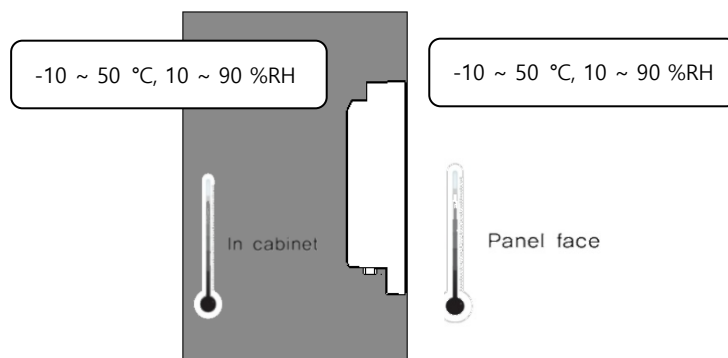

- (3) Ensure that external mechanical hazards are minimized in the device's operating environment.
- (4) Prepare and attach a protective sheet for your environment to the display. Otherwise, the product may be damaged or dirty, and foreign substances may enter the product and cause failure or malfunction.

6.2 Installation Procedure Warning

To install this product, be sure to follow the following items.

6.2.1 Panel Cutout

Prepare the mounting panel by cutting it to the dimensions shown in the table below, then install the product by inserting it into the hole.

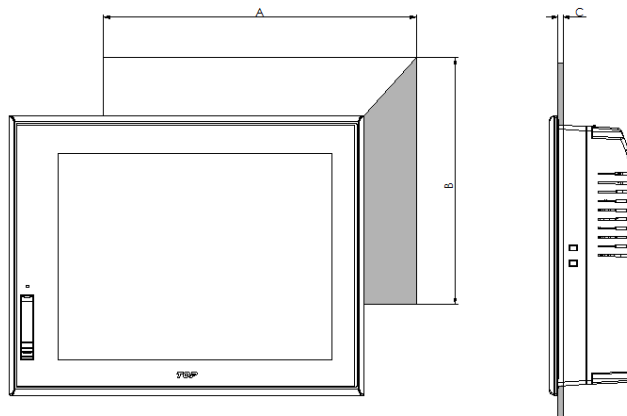

Model	A	B	C
TOPB0400WD	120.0 (+1.0 / 0)	91.0 (+1.0 / 0)	1.6 ~ 5.0 (+1.0 / 0)
TOPB0700WD	197.0 (+1.0 / 0)	127.0 (+1.0 / 0)	
TOPB1000WD	256.0 (+1.0 / 0)	166.0 (+1.0 / 0)	

(mm)

(2) Clamp Fixation

Install the included installation clamps with the following method to maintain the device's IP performance:

a. Insert the clamps attached to the device slots.

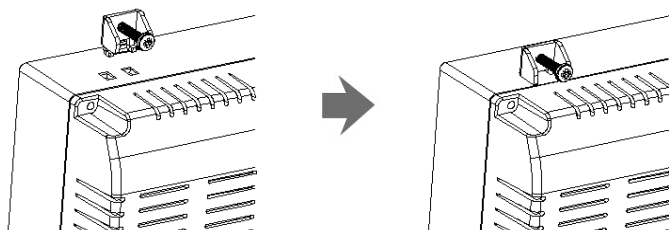

b. Tighten the device to the panel cut with a screwdriver.

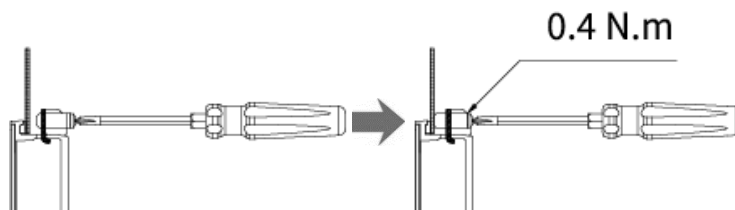



If the fixed clamp screws are over-tightened, the touch sensor may stop functioning or operate incorrectly. Please tighten with a driver torque of 0.4 N.m.

* CAUTION: Do not tighten the clamp with a clamping force of 0.4 Nm, as this will not ensure IP performance.

Chapter 7 Wiring Warning

7.1 Power Wiring Warning

(1) The Power cable should have the following specification.  Warning

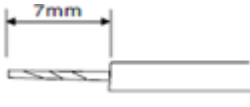
Power Cable Width	0.75 ~ 2.5 mm ² (18 ~ 13 AWG)
Grounding Cable Width	Over 2 mm ² (14 AWG)
Conductor Type	Single wire or stranded wire
Bolt Tightening Force	0.6 N.m  Warning
Conductor Length	
Wiring Conductor Temperature	65 °C

(2) The specifications for the power and ground terminals are as follows.  Warning

To prevent wear on the power wires and to improve the quality of electrical signal transmission, pin terminals (e.g., phenol pins or equivalent components) are used during the installation of power and ground terminals.

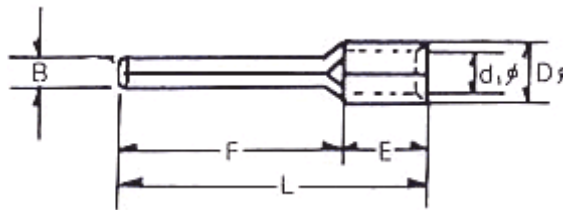

(mm)

B	L	F	E	D	d
1.8 ~ 2.0	14 ~ 22	8 ~ 14	5	3.3 ~ 3.8	2 ~ 2.5

(3) Wiring of power cable is as follows.  Warning

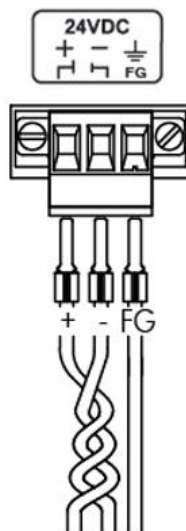

7.2 Grounding wiring Warning

- (1) The device has sufficient noise protection, but for the safety of both the device and the user, the user must connect the grounding of the device. When connecting the grounding, please follow the instructions below.
- (2) The grounding should preferably be connected to a dedicated ground. It is recommended to use a Type 3 Grounding system (the grounding resistance should be less than 100 Ω).
- (3) If a dedicated grounding is not possible, please use a shared grounding as shown in the diagram below.

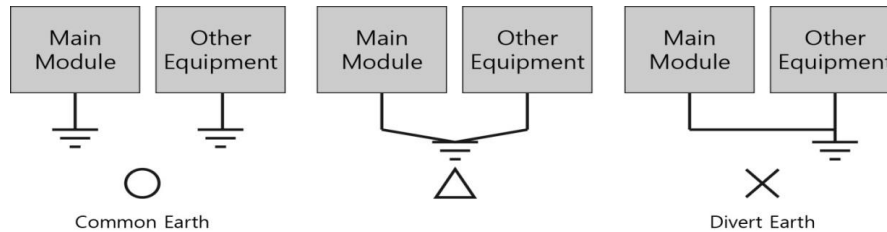

Fig. Grounding Example Diagram

- (4) Use a grounding wire with a cross-sectional area of at least 2 mm^2 . Place the grounding point as close as possible to the device and keep the grounding wire as short as possible.

Chapter 8 Maintenance Warning

8.1 Cleaning the Display

When the screen surface or frame becomes dirty, spray a cleaning solution onto a soft cloth and wipe the area clean. Do not spray the cleaning solution directly onto the screen.

8.2 Periodic Check Points

Check the followings periodically for best condition of the device.

(1) Environmental Check

- 1) Verify that the device is operating within the specified temperature range.
- 2) Verify that the device is operating within the specified humidity range.
- 3) Check for the presence of corrosive gases in the surrounding environment.

(2) Power Supply Check

- 1) Confirm that the input voltage is within the normal operating range.

(3) Other Related Checks

- 1) Visually inspect the touch panel for any damage, scratches, or contamination.
- 2) Check the replacement timing for the LCD backlight.

8.3 Device Troubleshooting Warning

- (1) If a problem occurs during operation, stop using the product immediately and contact M2I Co., Ltd.
- (2) M2I Co., Ltd., is not responsible for any damage or malfunction of the device caused by conditions that deviate from the installation and usage standards specified in the manual.
- (3) If excessive electromagnetic noise is emitted, attach ferrite cores to both the main unit power line and the field power line to reduce noise. Noise levels on power and communication lines may vary depending on the installation environment.
- (4) If USB devices do not operate properly due to noise, attaching ferrite cores to both ends of the cable can improve noise immunity.

8.4 Setting System Recovery Mode

- (1) If the device fails to boot properly due to an operational issue, system recovery can be performed using the setup switch on the rear of the product. System recovery boots from the recovery files stored in internal memory. If power is interrupted during the recovery process, recovery may not complete successfully.
- (2) Open the rear cover to access and adjust the setup switch. During normal operation, leave the switch in the "Normal" position. If system recovery is required, turn off the power, set the switch to "System Recovery" and then turn on the power to start recovery mode.
- (3) When recovery is complete, the buzzer will sound. At this point, turn off the power and return the setup switch to the "Normal" position.

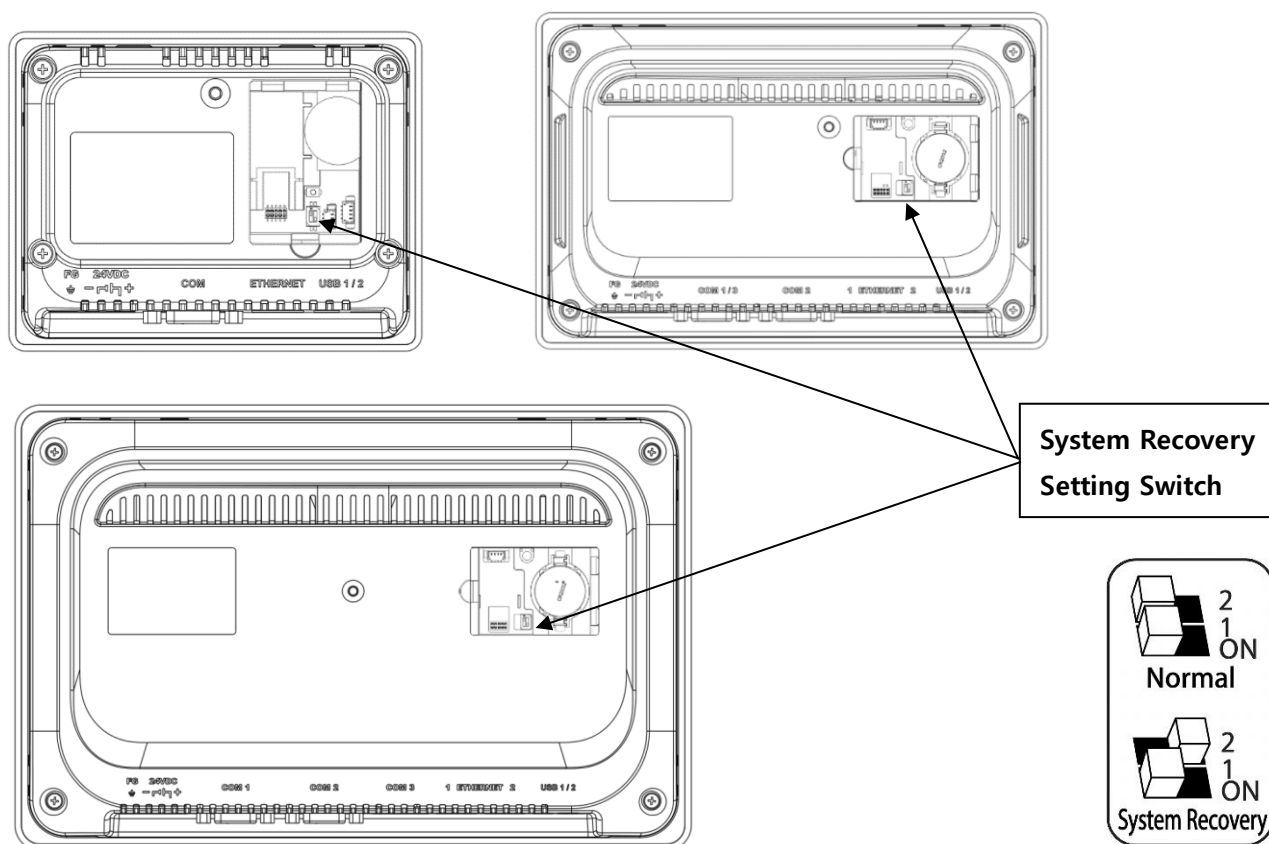

Chapter 9 Products Labels

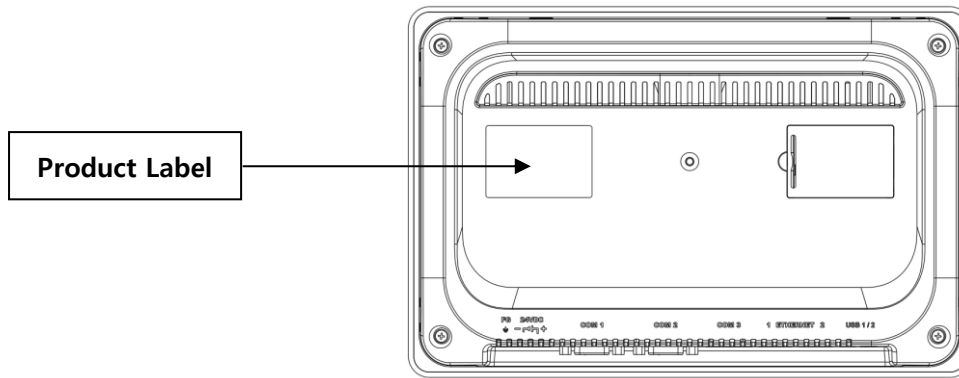

Manufacture (AS): M2I Corporation

11-35, Simin-daero 327beon-gil, Dongan-gu, Anyang-si, Gyeonggi-do 14055, Korea
Tel: 82-31-465-3366



Product Name: Industrial HMI Touch Panel

Model Name and Power Specifications:

- TOPRB0400WD: 24 Vdc, 15 W, Class 2 Power Only
- TOPRB0700WD: 24 Vdc, 15 W, Class 2 Power Only
- TOPRB1000WD: 24 Vdc, 15 W, Class 2 Power Only

Operating Temperature: $-10\text{ }^{\circ}\text{C} \leq T_a \leq +50\text{ }^{\circ}\text{C}$

KC Certificate No.: Serial Number:

Copyright: M2I Corporation 2026.06

www.mxon.co.kr

- When using M2I equipment, be sure to fully understand the relevant information provided in the manual, handle the product properly, and pay close attention to safety.
- Keep the manual in a safe place for future reference whenever necessary.